

# Stella Plugs

Stella plug gør det nemt at montere tunge emner som reoler, radiatorer, overskabe, armaturer, lamper og kanallister på gips-, spån-, masonit-, finér- og andre plader med hulrum bag.

**Materialer:** Tillex Stella plugs er produceret af Nylon (PA6 Halogenfri) og er temperaturbestandig fra  $-40^{\circ}\text{C}$  til  $+80^{\circ}\text{C}$ . Skruen er 4,8 El-galvaniseret stål, min. 5 my.

*These screw plugs are protected by EU Design N 778.345*



- Stor trækstyrke.
- Nem montage – UDEN at bruge specialværktøj.
- Fungerer også effektivt i hulrum med isolering.
- Ødelægger ikke gipspladen.
- Kan nemt demonteres.
- Metal møtrik i spidsen for holdbart resultat.
- Installationsvejledning: monteres med skruemaskine med moment, eller ved håndmontage

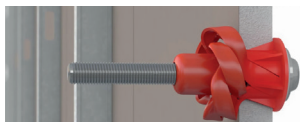

1 lag gips  
(13mm)



2 lag gips  
(26 mm)

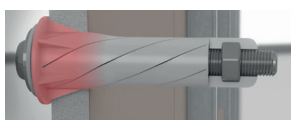
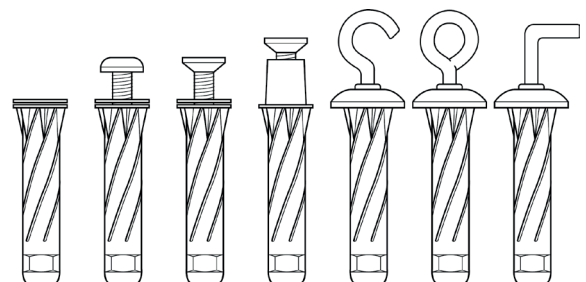

**OBS:** Indvendigt i spidsen af Tillex Stella plug sidder en metal møtrik. Når skruen får fat i den, trækker Stella pluggen sig sammen og danner en stjerne-knude i hulrummet på bagsiden af pladen. Herefter er montagen færdig.

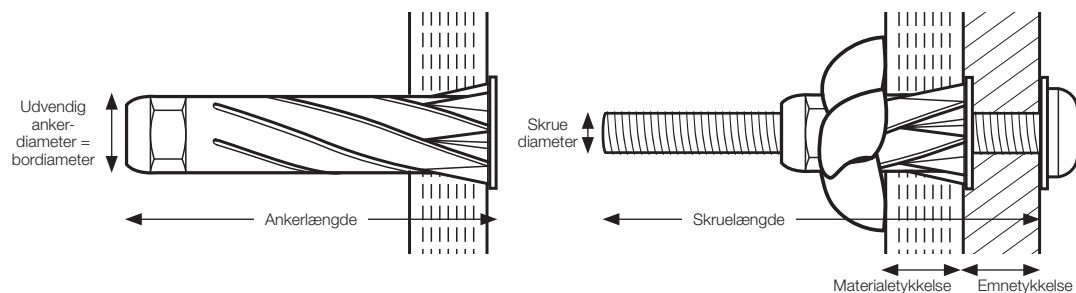

## Stella plug 10x49, for 1 lag gips

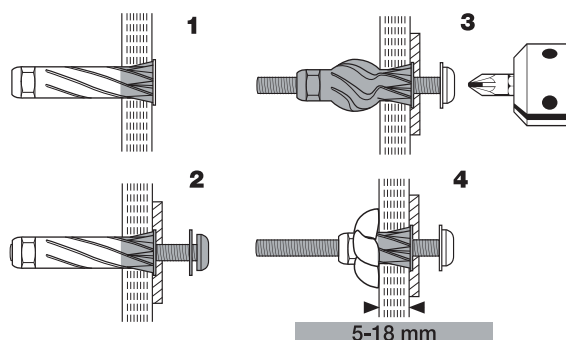





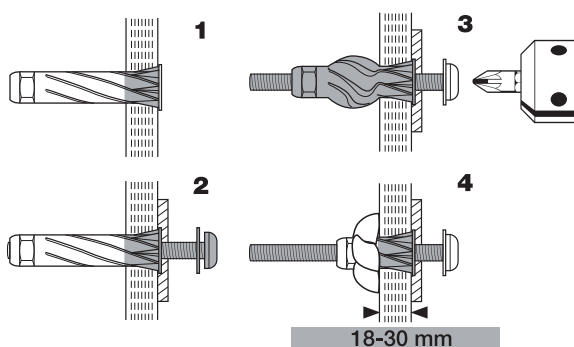



















| E-nummer     | Ref. Nr. | Type                           | EAN           | Skrue   | Farve | Antal/<br>æske |
|--------------|----------|--------------------------------|---------------|---------|-------|----------------|
| 8339 345 250 | 330005   | ST Red Pan Torx 25             | 5701925252844 | 5x55 mm | rød   | 25             |
| 8339 345 263 | 330007   | ST Red Pan Torx 25             | 5701925251342 | 5x80 mm | rød   | 25             |
| 8339 345 276 | 330011   | ST Red Pan PZ2                 | 5701925251540 | 5x55 mm | rød   | 25             |
| 8339 345 289 | 330013   | ST Red Pan PZ2                 | 5701925252943 | 5x80 mm | rød   | 25             |
| 8339 345 292 | 330016   | ST Red UHJ Torx 25             | 5701925251748 | 5x65 mm | rød   | 25             |
| 8339 345 302 | 330018   | ST Red UHJ Torx 25             | 5701925253049 | 5x80 mm | rød   | 25             |
| 8339 345 315 | 330021   | ST Red Collum Torx 25          | 5701925251946 | 5x65 mm | rød   | 25             |
| 8339 345 357 | 330026   | ST Red Eye                     | 5701925252349 | 5x55 mm | rød   | 25             |
| 8339 345 373 | 330031   | St Red Hook                    | 5701925252547 | 5x55 mm | rød   | 25             |
| 8339 345 399 | 330036   | St Red Angle                   | 5701925252745 | 5x55 mm | rød   | 25             |
| 8339 345 328 | 330009   | Stella Red 10x49 ohne Schraube | 5701925330009 |         | rød   | 50             |

## Stella Plug 10x59, for 2 lag gips



| E-nummer     | Ref. Nr. | Type                             | EAN           | Skrue   | Farve | Antal/<br>æske |
|--------------|----------|----------------------------------|---------------|---------|-------|----------------|
| 8339 345 412 | 330045   | ST Black Pan Torx 25             | 5701925253186 | 5x65 mm | sort  | 25             |
| 8339 345 425 | 330047   | ST Black Pan Torx 25             | 5701925251489 | 5x90 mm | sort  | 25             |
| 8339 345 438 | 330051   | ST Black Pan PZ2                 | 5701925251687 | 5x65 mm | sort  | 25             |
| 8339 345 441 | 330053   | ST Black Pan PZ2                 | 5701925253285 | 5x90 mm | sort  | 25             |
| 8339 345 454 | 330056   | ST Black UHJ Torx 25             | 5701925251885 | 5x75 mm | sort  | 25             |
| 8339 345 467 | 330058   | ST Black UHJ Torx 25             | 5701925253384 | 5x90 mm | sort  | 25             |
| 8339 345 470 | 330061   | ST Black Collum Torx 25          | 5701925252080 | 5x75 mm | sort  | 25             |
| 8339 345 506 | 330066   | ST Black Eye                     | 5701925252486 | 5x55 mm | sort  | 25             |
| 8339 345 522 | 330071   | ST Black Hook                    | 5701925252684 | 5x55 mm | sort  | 25             |
| 8339 345 548 | 330076   | ST Black Angle                   | 5701925252882 | 5x55 mm | sort  | 25             |
| 8339 345 344 | 330054   | Stella Black 10x59 ohne Schraube | 5701925330054 |         | sort  | 50             |

| Stella plug, rød  |   |   |          | Dimension                   |             |             |             |                       | Montage   |                        |          | Bæreevne*                 |
|-------------------|---|---|----------|-----------------------------|-------------|-------------|-------------|-----------------------|-----------|------------------------|----------|---------------------------|
| Typ               | Sortiment   | Bit   | Ref. nr. | Udvendig anker-diameter, mm | Anker L, mm | Skrue Ø, mm | Skrue L, mm | Max. emne-tykkelse mm | Bor-Ø, mm | Materiale-tykkelse, mm | Gips-lag | Anbefalet direkte træk kg |
| Red               |  | -   | 330009   | 10                          | 49          | M5          | -           | 0                     | 10        | 5-18                   | 1        | 20                        |
| Red Pan           |  | Torx 25  | 330005   | 10                          | 49          | M5          | 55          | 15                    | 10        | 5-18                   | 1        | 25                        |
|                   |   |   | 330007   | 10                          | 49          | M5          | 80          | 40                    | 10        | 5-18                   | 1        | 25                        |
| Red Pan           |  | PZ2      | 330011   | 10                          | 49          | M5          | 55          | 15                    | 10        | 5-18                   | 1        | 25                        |
|                   |   |   | 330013   | 10                          | 49          | M5          | 80          | 40                    | 10        | 5-18                   | 1        | 25                        |
| Red UHJ           |  | Torx 25  | 330016   | 10                          | 49          | M5          | 65          | 25                    | 10        | 5-18                   | 1        | 25                        |
|                   |   |   | 330018   | 10                          | 49          | M5          | 80          | 40                    | 10        | 5-18                   | 1        | 25                        |
| Red Collum        |  | Torx 25  | 330021   | 10                          | 49          | M5          | 65          | 12                    | 10        | 5-18                   | 1        | 25                        |
| Red Øje (Ø13mm)   |  |   | 330026   | 10                          | 49          | M5          | 55          | 0                     | 10        | 5-18                   | 1        | 20                        |
| Red Krog (Ø 13mm) |  |   | 330031   | 10                          | 49          | M5          | 55          | 0                     | 10        | 5-18                   | 1        | 20                        |
| Red Vinkel        |  |   | 330036   | 10                          | 49          | M5          | 55          | 0                     | 10        | 5-18                   | 1        | 20                        |

| Stella plug, sort   |   |   |          | Dimension                   |             |             |             |                       | Montage   |                        |          | Bæreevne*                 |
|---------------------|---|---|----------|-----------------------------|-------------|-------------|-------------|-----------------------|-----------|------------------------|----------|---------------------------|
| Typ                 | Sortiment   | Bit   | Ref. nr. | Udvendig anker-diameter, mm | Anker L, mm | Skrue Ø, mm | Skrue L, mm | Max. emne-tykkelse mm | Bor-Ø, mm | Materiale-tykkelse, mm | Gips-lag | Anbefalet direkte træk kg |
| Black               |  | -   | 330054   | 10                          | 59          | M5          | -           | 0                     | 10        | 18-30                  | 2        | 20                        |
| Black Pan           |  | Torx 25  | 330045   | 10                          | 59          | M5          | 65          | 12                    | 10        | 18-30                  | 2        | 45                        |
|                     |   |   | 330047   | 10                          | 59          | M5          | 90          | 38                    | 10        | 18-30                  | 2        | 45                        |
| Black Pan           |  | PZ2      | 330051   | 10                          | 59          | M5          | 65          | 12                    | 10        | 18-30                  | 2        | 45                        |
|                     |   |   | 330053   | 10                          | 59          | M5          | 90          | 38                    | 10        | 18-30                  | 2        | 45                        |
| Black UHJ           |  | Torx 25  | 330056   | 10                          | 59          | M5          | 75          | 23                    | 10        | 18-30                  | 2        | 45                        |
|                     |   |   | 330058   | 10                          | 59          | M5          | 90          | 38                    | 10        | 18-30                  | 2        | 45                        |
| Black Collum        |  | Torx 25  | 330061   | 10                          | 59          | M5          | 75          | 12                    | 10        | 18-30                  | 2        | 45                        |
| Black Øje (Ø 13mm)  |  |   | 330066   | 10                          | 59          | M5          | 55          | 0                     | 10        | 18-30                  | 2        | 20                        |
| Black Krog (Ø 13mm) |  |   | 330071   | 10                          | 59          | M5          | 55          | 0                     | 10        | 18-30                  | 2        | 20                        |
| Black Vinkel        |  |   | 330076   | 10                          | 59          | M5          | 55          | 0                     | 10        | 18-30                  | 2        | 20                        |

**OBS:** Vær opmærksom på at hulrummet bag plade minimum skal være (højeste resultat af følgende udregninger):

1. Ankerlængde minus materialetykkelse eller 2. Skruelængde minus (materialetykkelse og emnetykkelse)

\*Bæreevne er anbefalet maksimum belastning i gipsplader ved en afstand på minimum 300 mm mellem hver Stella plug.

Sikkerhedsfaktor 3 er indregnet. 1 kN ≈ 100 kg.

**OBS:** Kan anbefalede mål og afstande ikke overholdes, reduceres bæreevnen.